

Fiber-Fiber™ 1X4 Fiber Optical Switch

(SM, PM, MM, Bidirectional)



DATASHEET

[Return to the Webpage](#)

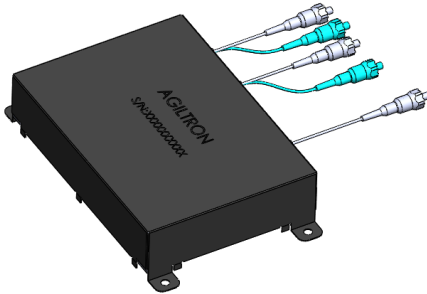

Applications

- Protection
- Instrumentation

Features

- Low Optical Distortions
- High Isolation
- High Reliability
- Fail-Safe Latching
- Epoxy-Free Optical Path
- Low Cost

The FF Series fiber optic switch connects optical channels by a micro-mechanical fiber to a fiber auto-alignment platform and is activated via an electrical relay. The advanced design significantly increases the performance, offering unprecedentedly low optical loss, broad wavelength operation with no coatings, high power handling, and an unmatched low cost. The latching operation preserves the selected optical path after removing the driver signal. The switch is bidirectional and conveniently controllable by 5V TTL.

Using no lens, the FF Series switch can accommodate all types of fibers, including SM, MM, PM, double cladding, bendable, large core, small core.

Lightpath in the device is bidirectional.

This switch uses a specially formulated index-matching liquid that does not generate fluorescent. The liquid fills a gap of less than 5 μm .

Switches with PM fibers transmit both polarizations the same way as the fiber.

Specifications

Parameter	Min	Typical	Max	Unit
Wavelength	200		2500	nm
Insertion Loss ^[1]		0.6	1	dB
Cross Talk On/Off Ratio		50	60	dB
Wavelength Dependent Loss		0.05	0.1	dB
Polarization Dependent Loss			0.1	dB
Polarization Extinction Ratio ^[2]	18	25	27	
Return Loss	35 ^[3]	55		dB
Rise/Fall Time (low speed version)	5		40 ^[4]	ms
Rise/Fall Time (high speed version)	1	2	15 ^[5]	ms
Repeatability			± 0.02	dB
Durability	10^7			Cycles
Repetition Rate			5	Hz
Operating Optical Power ^[2]		0.5		W
Operating Voltage	4.3		4.5	VDC
Operating Current (Latching/Non-Latching)		30	70	mA
Switching Type	Latching / Non-Latching			
Operating Temperature	-20 ~ 80			°C
Storage Temperature	-40 ~ 85			°C

Notes:

- [1]. SM 28 fiber, Excluding Connectors. For MM fiber with laser CPR<14
- [2]. For PM fiber only
- [3]. For MM fiber with laser CPR<14
- [4]. For PM type mainly
- [5]. For SM, MM type, 15ms including the electrical delay as shown in the testing data

Legal notices: All product information is believed to be accurate and is subject to change without notice. Information contained herein shall legally bind Agiltron only if it is specifically incorporated into the terms and conditions of a sales agreement. Some specific combinations of options may not be available. The user assumes all risks and liability whatsoever in connection with the use of a product or its application.

Rev 04/25/25

Fiber-Fiber™ 1X4 Fiber Optical Switch

(SM, PM, MM, Bidirectional)



DATASHEET

Mechanical Dimensions (mm)

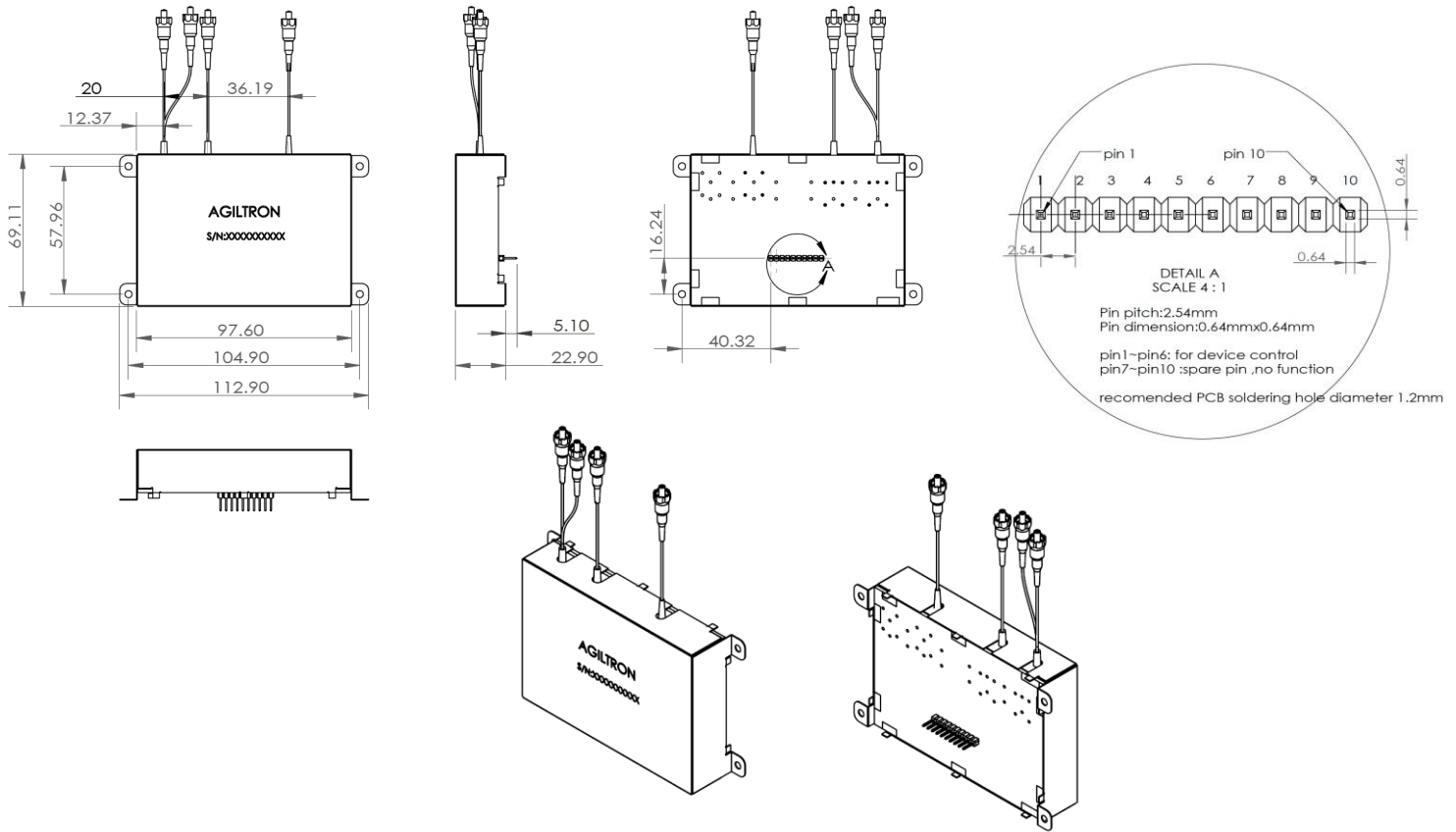

*Product dimensions may change without notice. This is sometimes required for non-standard specifications.

Electrical Connector Configurations

The load is a resistive coil which is activated by applying 4.5V (draw ~ 40mA). Applying a constant driving voltage increases stability. The switches can also be driven by a pulse mode using Agiltron recommended circuit for energy saving.

Agiltron offers a computer control kit with TTL and USB interfaces and Windows™ GUI. We also offer RS232 interface as an option – please contact Agiltron sales.

Latching Type

Optical Path	Switch 1		Switch 2		Switch 3	
	Pin 1	Pin 2	Pin 3	Pin 4	Pin 5	Pin 6
Port 1 → Port 2	L	H	L	H		
Port 1 → Port 3	L	H	H	L		
Port 1 → Port 4	H	L			L	H
Port 1 → Port 5	H	L			H	L

Notes:

- H – 4.5V
- L – 0V
- Empty – Don't care H or L

Non-Latching Type

Optical Path	Switch 1		Switch 2		Switch 3	
	Pin 1	Pin 2	Pin 3	Pin 4	Pin 5	Pin 6
Port 1 → Port 2	L	L	L	L		
Port 1 → Port 3	L	L	H	L		
Port 1 → Port 4	H	L			L	L
Port 1 → Port 5	H	L			H	L

Notes:

- H – 4.5V
- L – 0V
- Empty – Don't care H or L

Fiber-Fiber™ 1X4 Fiber Optical Switch

(SM, PM, MM, Bidirectional)



DATASHEET

Functional Diagram

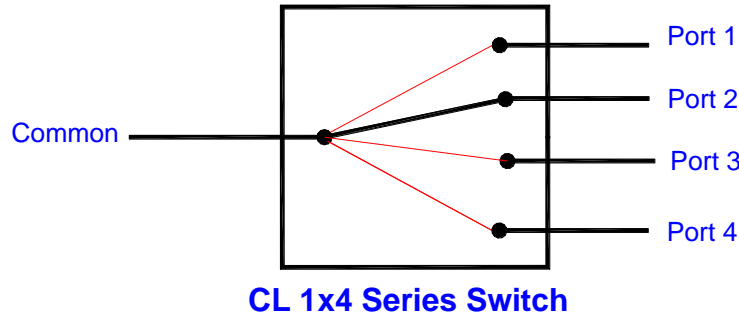

Manual Operation Instruction

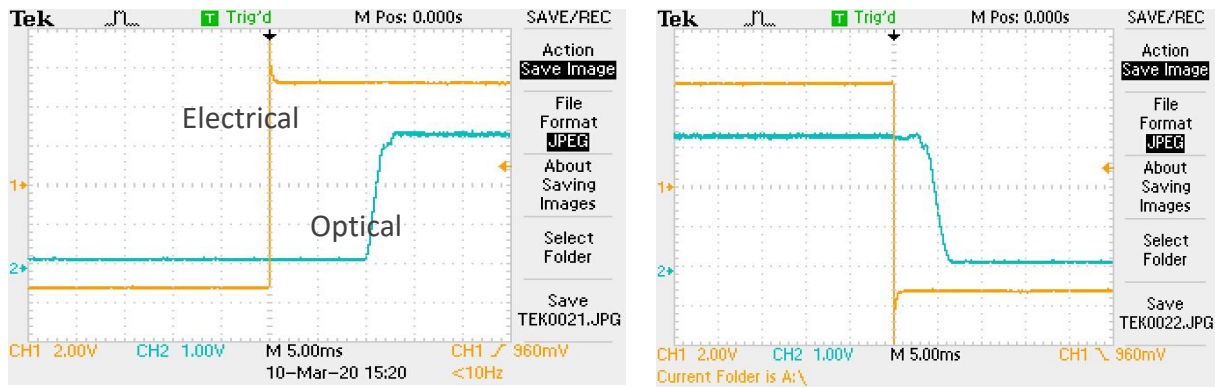

Rise

Fall

Fiber-Fiber™ 1X4 Fiber Optical Switch

(SM, PM, MM, Bidirectional)



DATASHEET

Switch Mounted On Driver PCB with USB/RS232 Interface, 5V DC Input

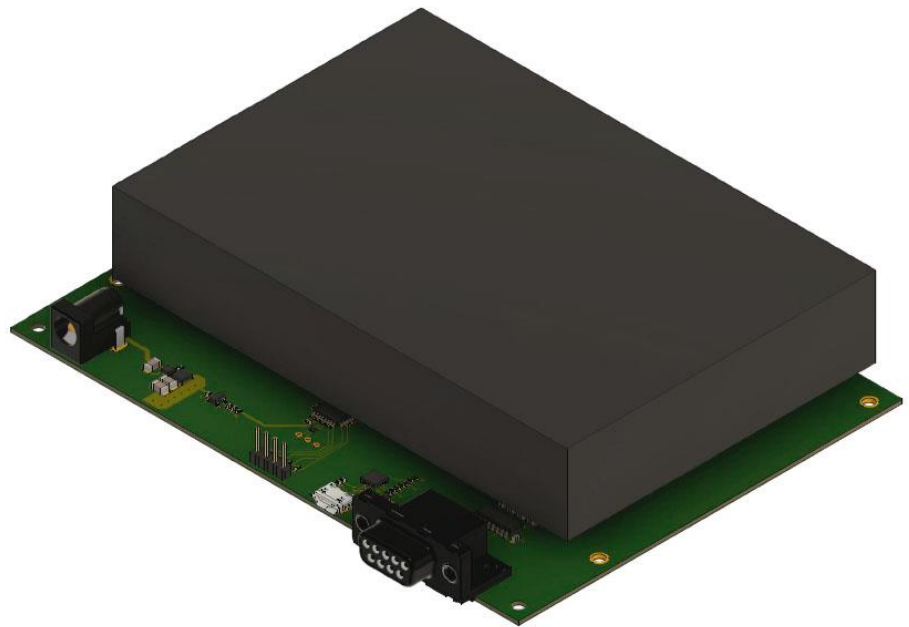
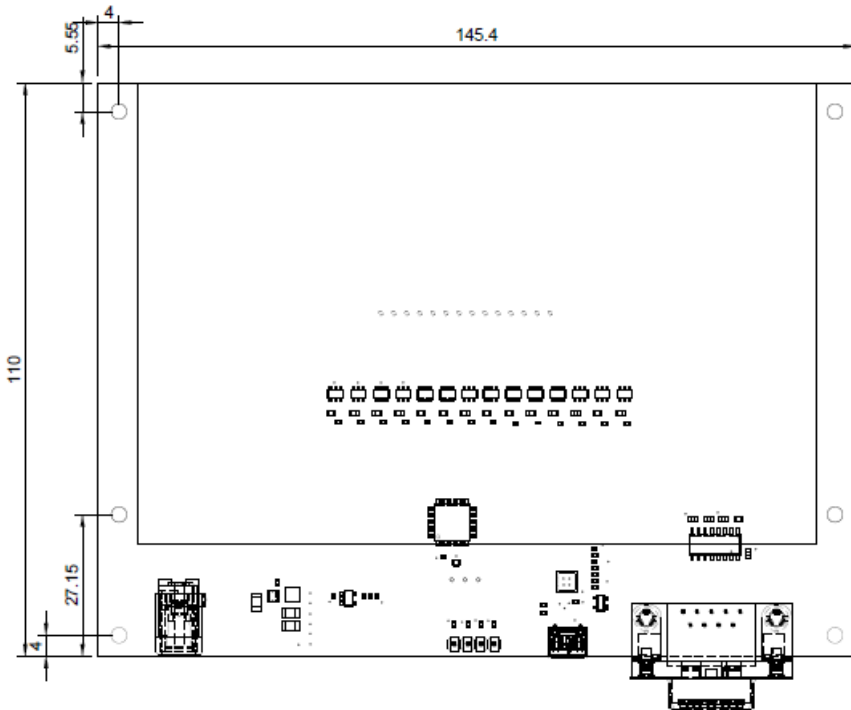

Fiber-Fiber™ 1X4 Fiber Optical Switch

(SM, PM, MM, Bidirectional)



DATASHEET

Ordering Information

Prefix	Type	Switch	Test Wavelength ^[1]	Fiber Type	Fiber Cover	Fiber Length	Connector	Driver	Benchtop ^[2]
FFSW-	1x4 = 14 1x3 = 13	Fast Latching (F) = 6 Fast Non-Latching (F) = 7 Slow Latching (S) = 2 Slow Non-Latching (S) = 3	488 = 4 532 = 5 630 = 6 780 = 7 850 = 8 980 = 9 1060 = 1 1310 = 3 1550 = C 2000 = 2 2.3-4.1 μm = F 3.2-5.5 μm = G Special = 0	Pick from below table	Bare fiber = 1 900um tube = 3 Special = 0	0.25m = 1 0.5m = 2 1.0m = 3 Special = 0	None = 1 FC/PC = 2 FC/APC = 3 SC/PC = 4 SC/APC = 5 ST/PC = 6 LC/PC = 7 Duplex LC/PC = 8 MTP = 9 LC/APC = A LC/UPC = U Special = 0	Non = 1 USB = 2 RS232 = 3 TTL = 4	Non = 1 Yes = 2

[1]. The device is ultra-broadband limited by the fiber transmission. However, we only test at one selected wavelength to save cost. If customer needs to test at several wavelengths, the selection is **Special=0** with added cost.

[2]. The benchtop integrates the modulator, driver, and power supply. Front Panel: SMA 0-5V electrical control input port for precise modulation. Fiber input and output ports with standard FC/APC connectors. Back Panel: 100-240 VAC power input for global compatibility and a Power switch for easy on/off control. This all-in-one design simplifies setup and operation

Note:

- PM1550** fiber works well for **1310nm**

Fiber Type Selection Table:

01	SMF-28	34	PM1550	67	OM1 (MMF 62.5/125μm)
02	SMF-28e	35	PM1950	68	OM2 (MMF 50/125μm)
03	Corning XB	36	PM1310	69	OM3 (MMF 50/125μm)
04	SM450	37	PM400	70	OM4 (MMF 50/125μm)
05	SM1950	38	PM480	71	GIF50 (GIF 50/125μm)
06	SM600	39	PM630	72	GIF625 (GIF 62.5/125μm)
07	Hi780	40	PM850	73	105/125μm
08	SM800	41	PM980	74	FG105LCA
09	Hi980	42		75	FG50LGA
10	Hi1060	43	PM780	76	
11	Draka BBE	44		77	IRZS23
12		45		78	IRZS32
13		46		79	
				80	
				81	UV180nm

Benchtop Box Mechanical Dimension

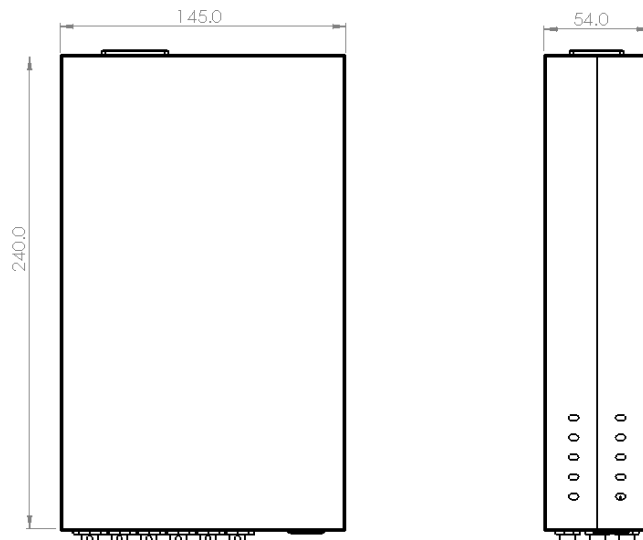

*Product dimensions may change without notice. This is sometimes required for non-standard specifications.

Fiber-Fiber™ 1X4 Fiber Optical Switch

(SM, PM, MM, Bidirectional)



DATASHEET

Typical Fiber Transmissions

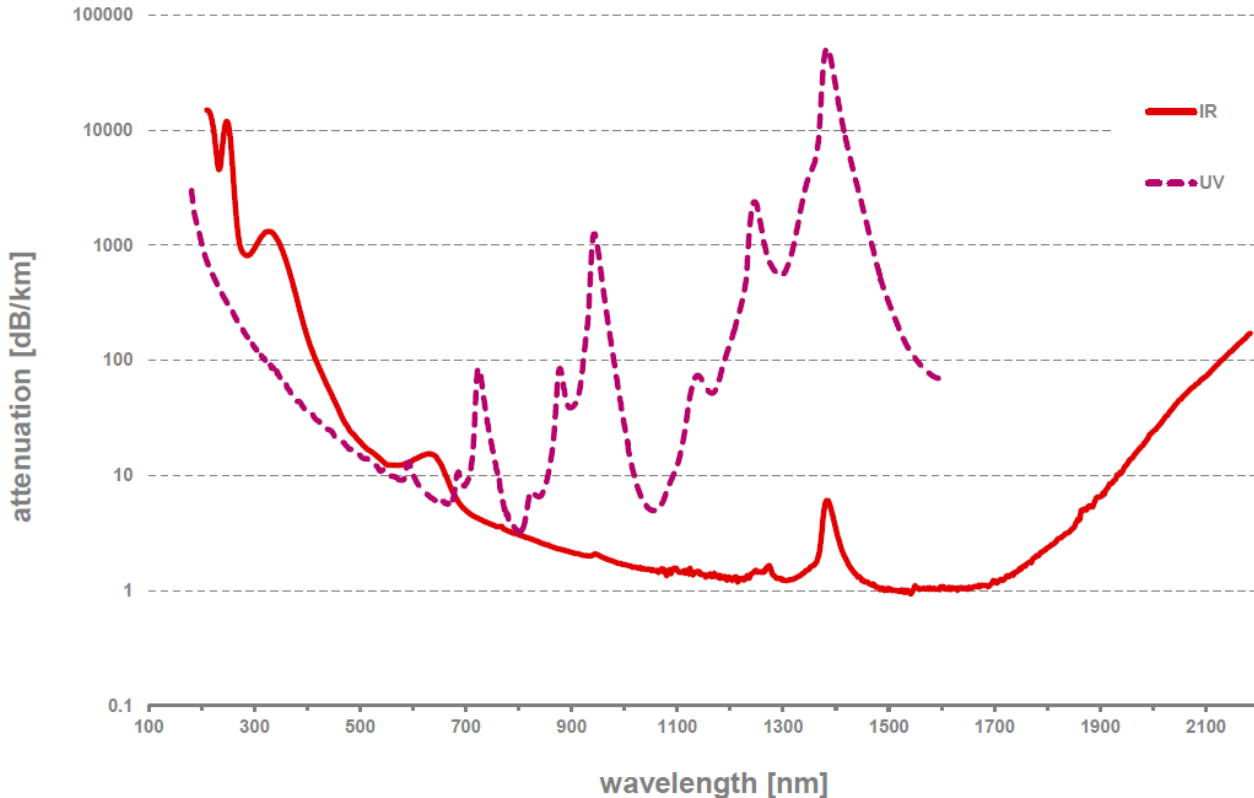

Application Notes

Fiber Core Alignment

Note that the minimum attenuation for these devices depends on excellent core-to-core alignment when the connectors are mated. This is crucial for shorter wavelengths with smaller fiber core diameters that can increase the loss of many decibels above the specification if they are not perfectly aligned. Different vendors' connectors may not mate well with each other, especially for angled APC.

Fiber Cleanliness

Fibers with smaller core diameters (<5 μm) must be kept extremely clean, contamination at fiber-fiber interfaces, combined with the high optical power density, can lead to significant optical damage. This type of damage usually requires re-polishing or replacement of the connector.

Maximum Optical Input Power

Due to their small fiber core diameters for short wavelength and high photon energies, the damage thresholds for device is substantially reduced than the common 1550nm fiber. To avoid damage to the exposed fiber end faces and internal components, the optical input power should never exceed 20 mW for wavelengths shorter 650nm. We produce a special version to increase the how handling by expanding the core side at the fiber ends.

Fiber-Fiber™ 1X4 Fiber Optical Switch

(SM, PM, MM, Bidirectional)



DATASHEET

Driver Reference Design

